

# Torrance Occasional Chair

Thank you for purchasing Torrance Occasional Chair. Please follow the manufacturer's assembly instructions in detail.

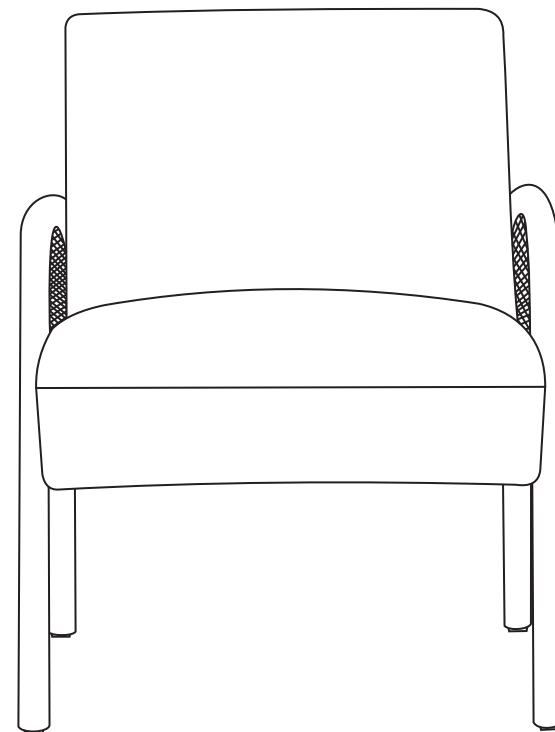
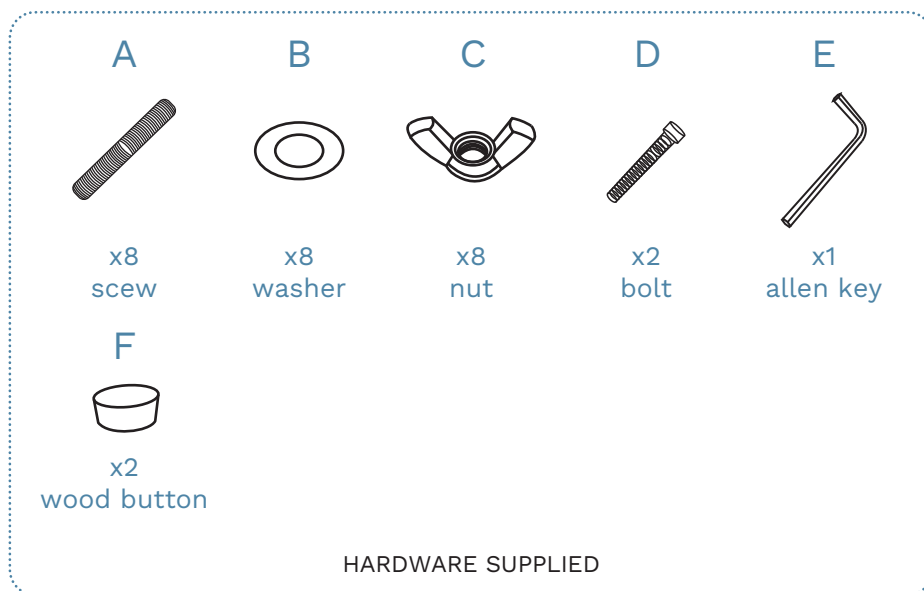

# Torrance Occasional Chair

1

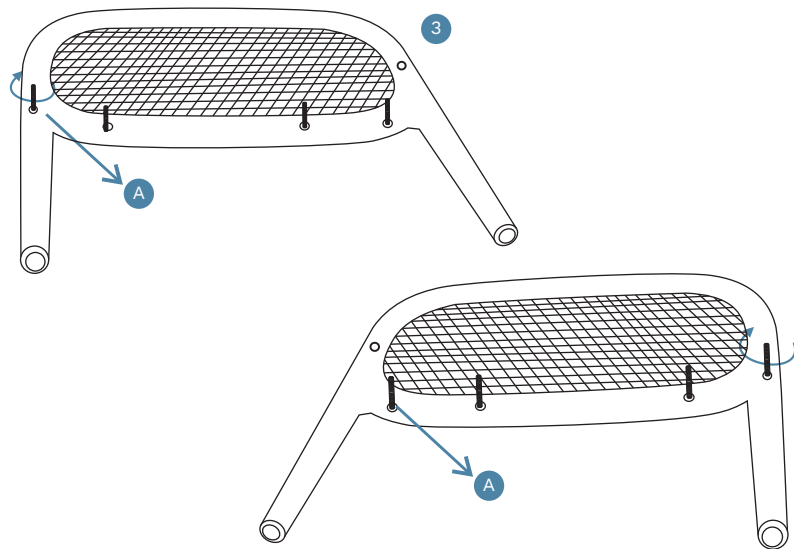

Attach 8 x screws (A) into legs (3) and (4) as shown.

2

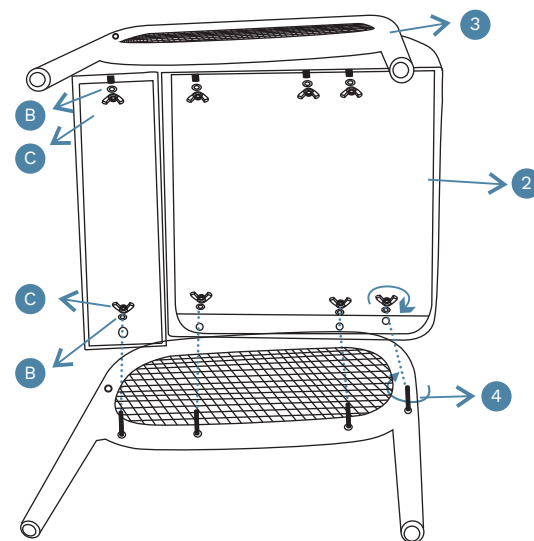

Attach cushion (2) to legs (3) and (4) and secure with 8 x nuts (C) and 8 x washers (B). Tighten the nuts as shown.

# Torrance Occasional Chair

## 3

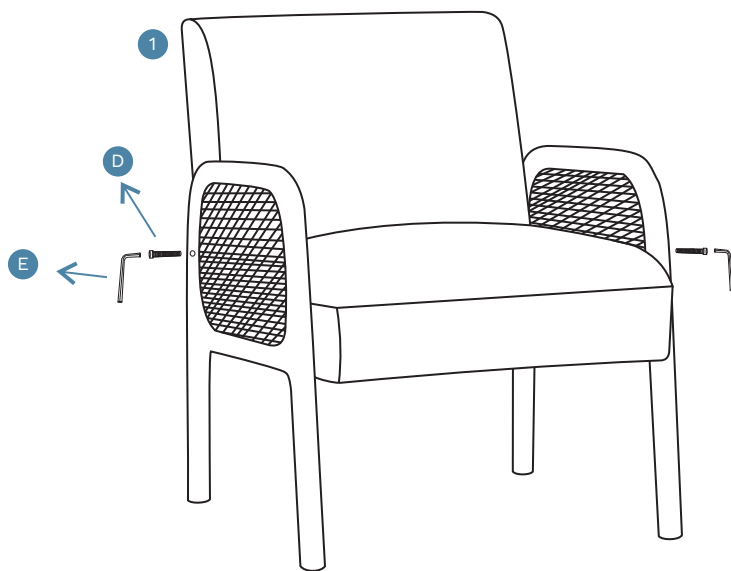

Attach backrest (1) to assembled frame and secure with 2 x screws (D). Tighten with an allen key (E).

## 4

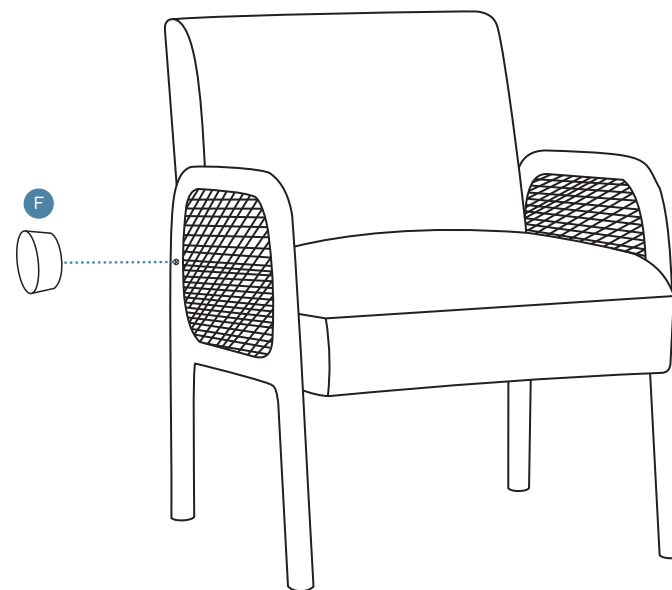

Attach 2 x wooden button (F) to assembled frame as shown.

# Torrance Occasional Chair

## 5

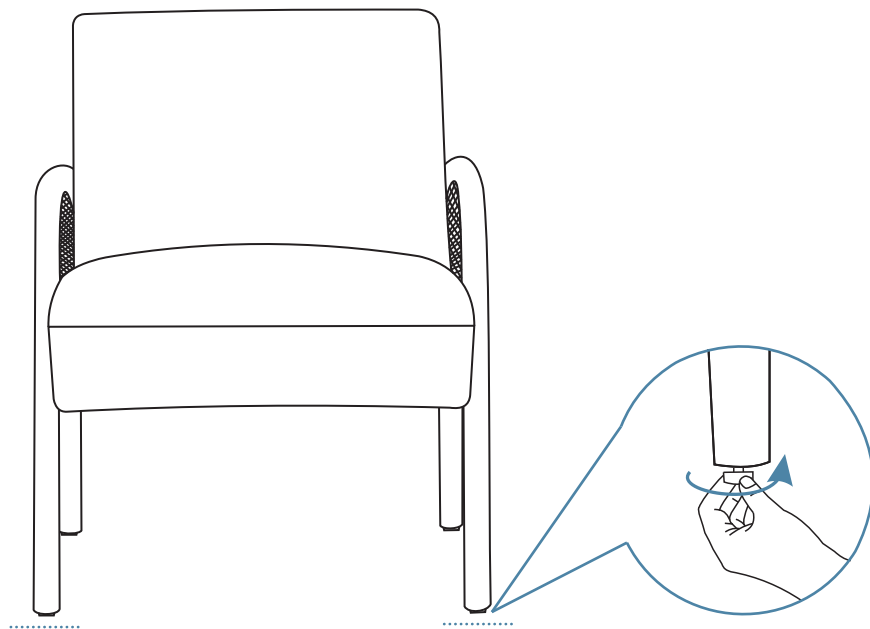

Adjust footrests as shown to ensure unit is level with flooring.

## 6

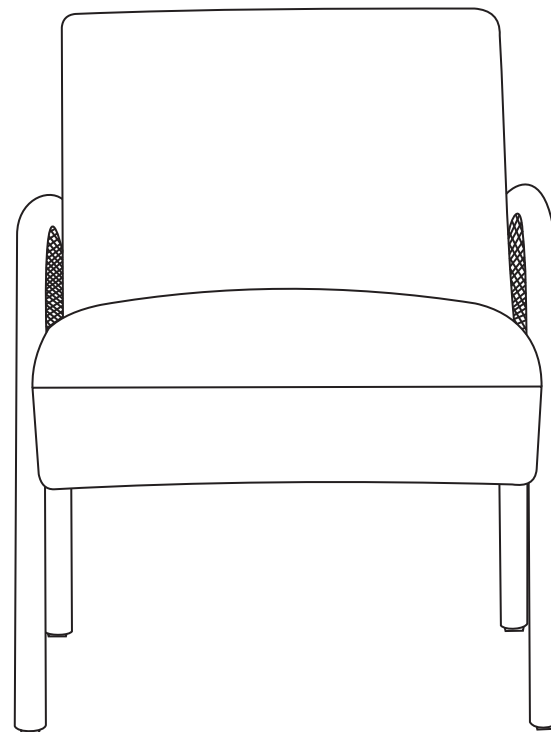

Once assembled lift furniture into place, do not drag. Ensure unit is balanced and steady before use. You're done, enjoy!